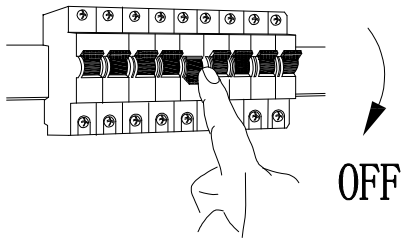
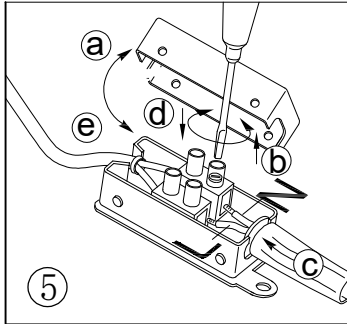
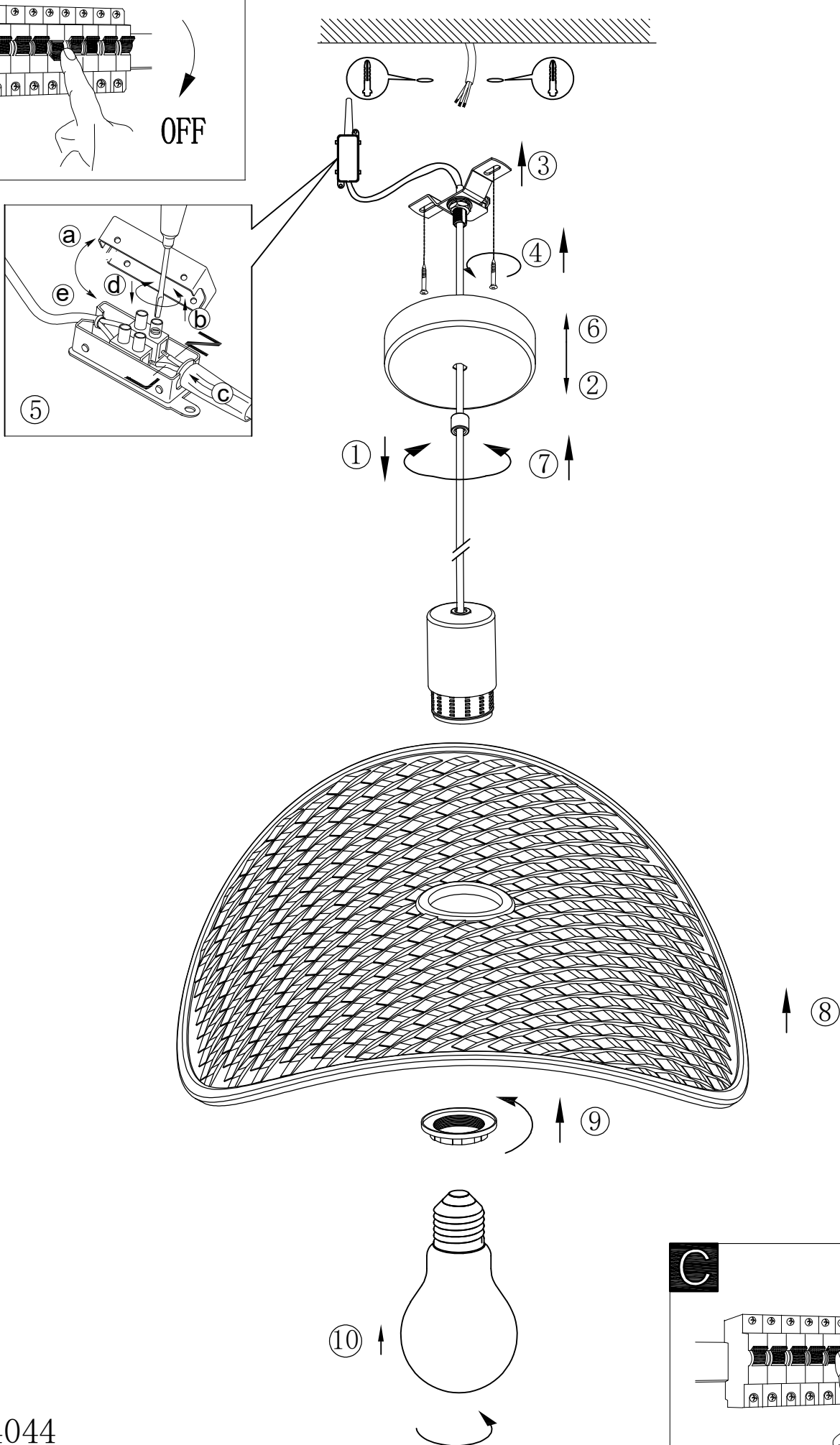
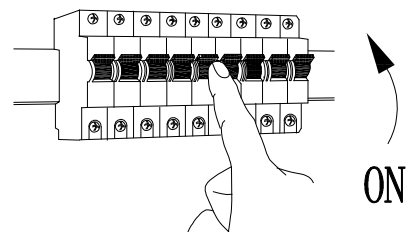

A**B****C**

B44044
www.eglo.com